

TOP VIEW

BOTTOM VIEW

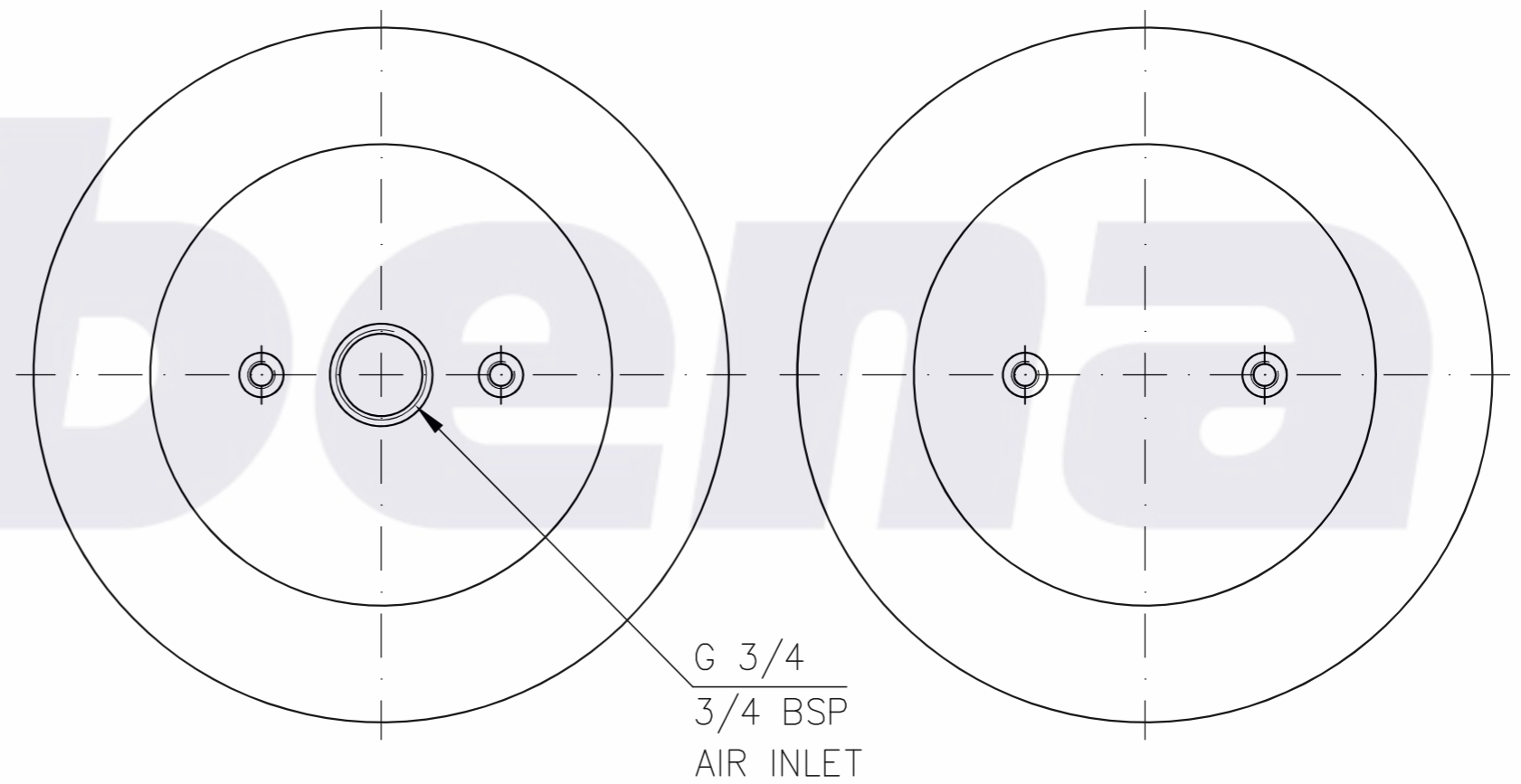

Dunlop design line - 8" x 1 Crimped